

MODEL: CMS-34348N | **DESCRIPTION:** SPEAKER

FEATURES

- miniature speaker
- 380 Hz resonant frequency
- Nd-Fe-B magnet

SPECIFICATIONS

parameter	conditions/description	min	typ	max	units
input power	maximum power: IEC-60268-5, filter 60s on/120s off, 10 cycles at room temp		3.0	4.0	W
impedance	at 1.0 kHz, 1.0 V	6.8	8	9.2	Ω
resonant frequency (Fo)	at 1.0 V	304	380	456	Hz
frequency response	output SPL -10 dB	Fo		10,000	Hz
sound pressure level	at 1.0 W, 0.5 m ave, at 0.8, 1.0, 1.2, 1.5 kHz	77	80	83	dB
	at 3.0 W, 0.5 m ave, at 0.8, 1.0, 1.2, 1.5 kHz	82	85	88	dB
distortion	at 1.0 kHz, 1.0 W			5	%
buzz, rattle, etc.	must be normal at sine wave between Fo ~ 20,000 Hz		4.9		V
dimensions	34 x 34 x 14.5				mm
magnet	Nd-Fe-B				
material	ABS77D				
cone material	mylar				
terminal	solder terminals				
weight			30		g
operating temperature		-20		55	$^{\circ}$ C
storage temperature		-30		65	$^{\circ}$ C
RoHS	2011/65/EU				

Notes: 1. All specifications measured at 5~35 $^{\circ}$ C, humidity at 45~85%, under 86~106 kPa pressure, unless otherwise noted.

SOLDERABILITY

parameter	conditions/description	min	typ	max	units
hand soldering	for maximum 3 seconds	370	380	390	$^{\circ}$ C

MECHANICAL DRAWING

units: mm
tolerance: ±0.5 mm

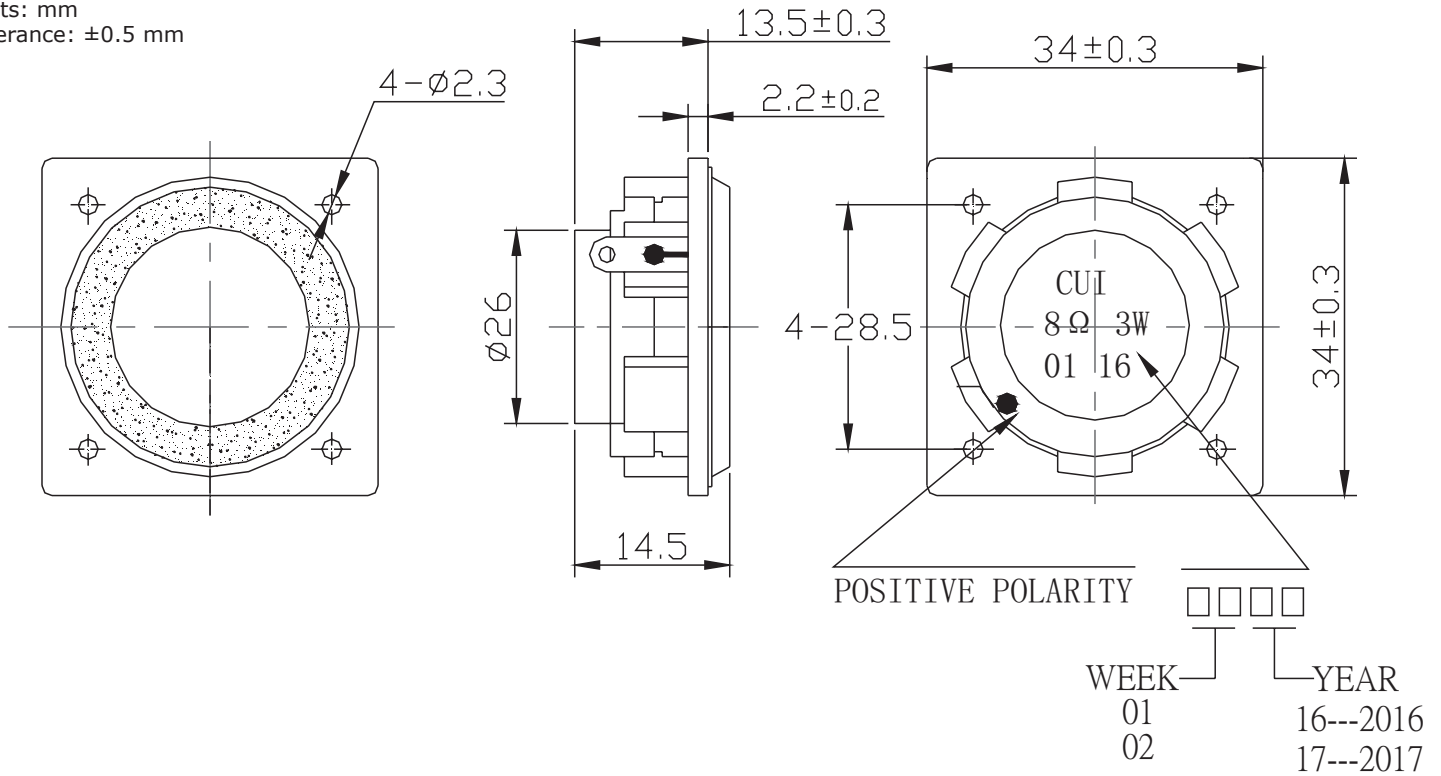

FREQUENCY RESPONSE CURVE

Frequency Response.Magn dB re 20.00 μ PA AT 1 W / 0.5 m

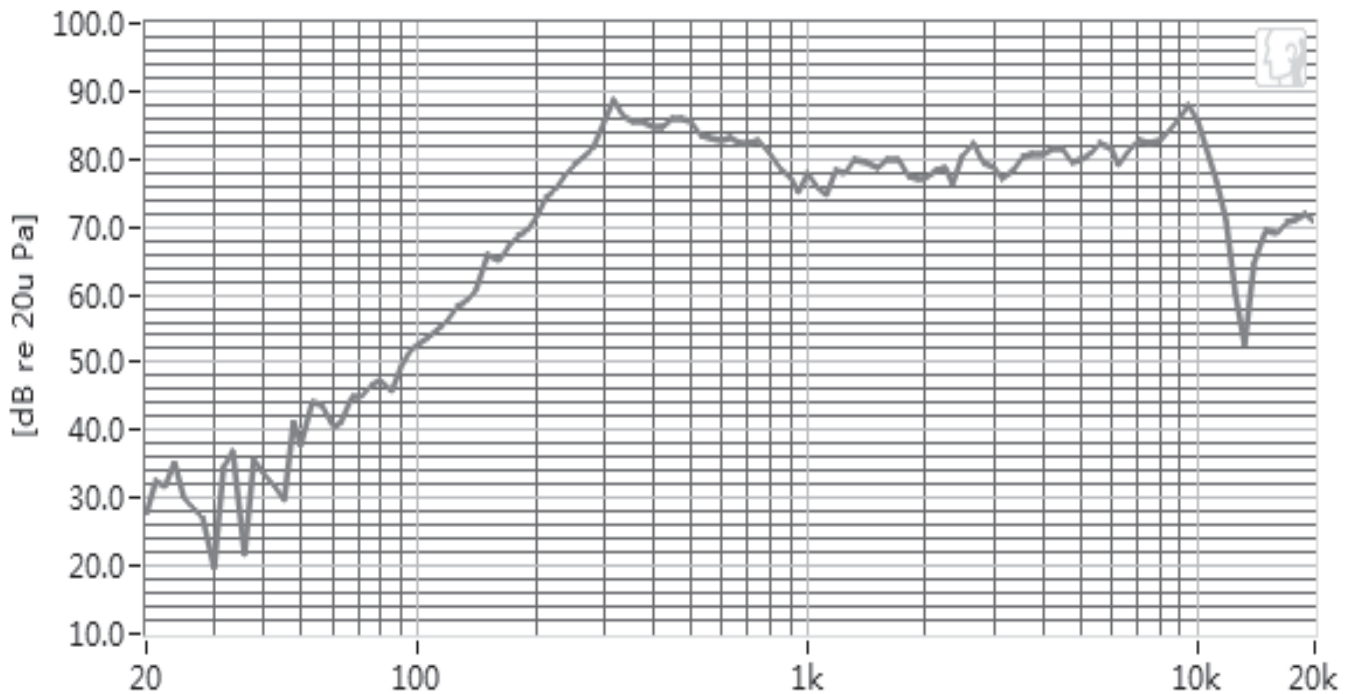

PACKAGING

units: mm

Tray Size: 400 x 200 x 18 mm
 Carton Size: 420 x 215 x 275 mm
 Tray QTY: 20 pcs per tray
 Carton QTY: 280 pcs per carton

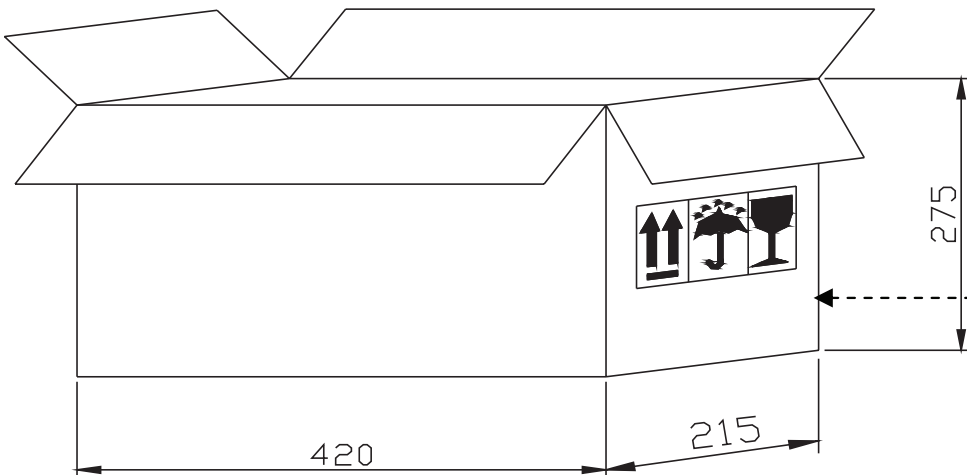
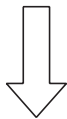
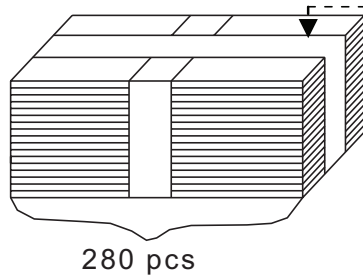
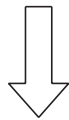
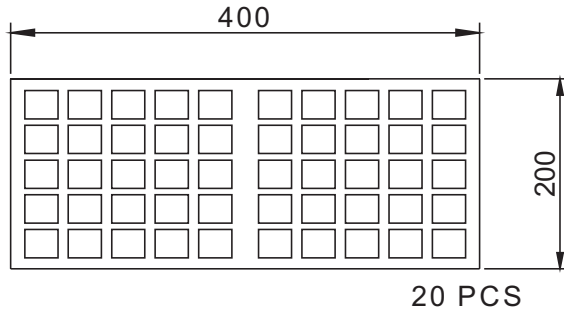

Lot No.	XXXXXXXXXX
Model No.	CUI Inv#. XXXXXXXXXXXX CUI Part#. XXXXXXXXXXXX
Quantity.	XXXX Pcs
Date:	DD MM YY 
	MADE IN CHINA
	CUI Inc

* The label stucked on inner boxes and the outer of carton.

REVISION HISTORY

rev.	description	date
1.0	initial release	06/28/2016

The revision history provided is for informational purposes only and is believed to be accurate.



Headquarters
20050 SW 112th Ave.
Tualatin, OR 97062
800.275.4899

Fax 503.612.2383
cui.com
techsupport@cui.com

CUI offers a one (1) year limited warranty. Complete warranty information is listed on our website.

CUI reserves the right to make changes to the product at any time without notice. Information provided by CUI is believed to be accurate and reliable. However, no responsibility is assumed by CUI for its use, nor for any infringements of patents or other rights of third parties which may result from its use.

CUI products are not authorized or warranted for use as critical components in equipment that requires an extremely high level of reliability. A critical component is any component of a life support device or system whose failure to perform can be reasonably expected to cause the failure of the life support device or system, or to affect its safety or effectiveness.