

LINNEA-Z2T25

Double asymmetric beam optimized for 1.0 mm metal sheet or profile

TECHNICAL SPECIFICATIONS:

Dimensions	285x40 mm
Height	10.3 mm
Fastening	clips
Colour	clear
Box size	578 x 378 x 295 mm
Box weight	8.6 kg
Quantity in Box	180 pcs
ROHS compliant	yes ⓘ



MATERIAL SPECIFICATIONS:

Component	Type	Material	Colour
LINNEA-Z2T25	Lens	PC	clear

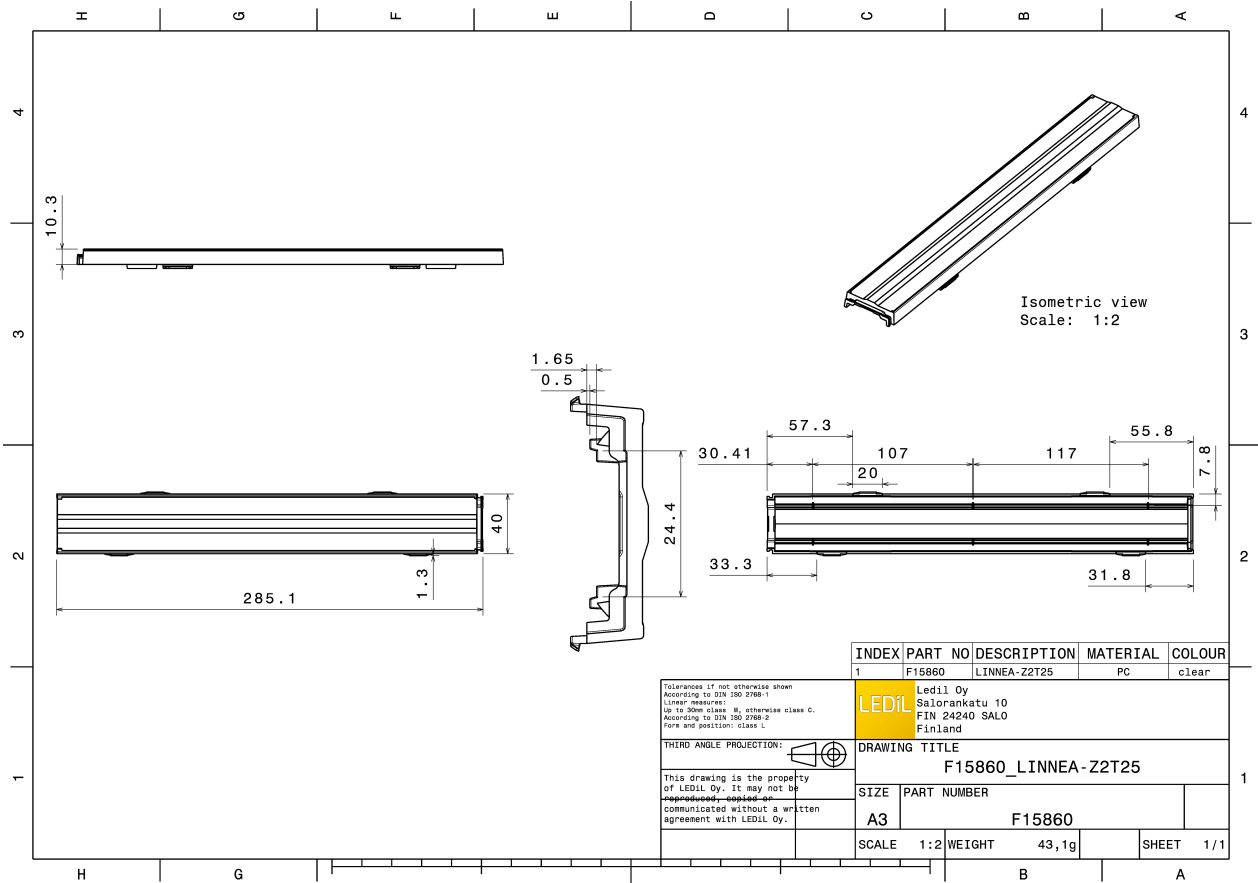

PHOTOMETRIC DATA (MEASURED):



LED CALOSNU405-M7W1
FWHM Asymmetric
Efficiency 86 %
Peak intensity 0.500 cd/lm
Required components:

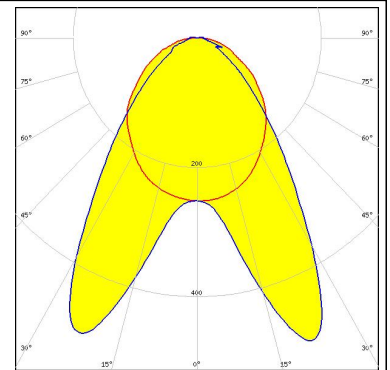

LED CALOSNU410-M7W1
FWHM Asymmetric
Efficiency 86 %
Peak intensity 0.510 cd/lm
Required components:

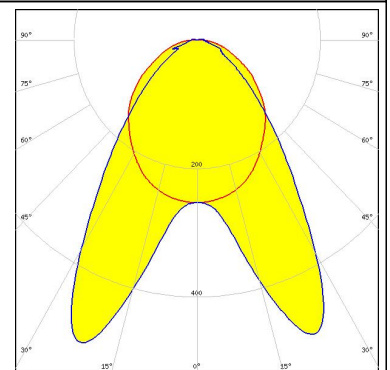

LED Tridino 1ft 1100lm xxxHE 1R HV
FWHM Asymmetric
Efficiency 88 %
Peak intensity 0.520 cd/lm
Required components:

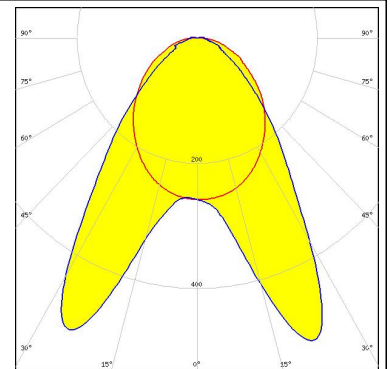

LED XP-E
FWHM Asymmetric
Efficiency 86 %
Peak intensity 0.520 cd/lm
Required components:

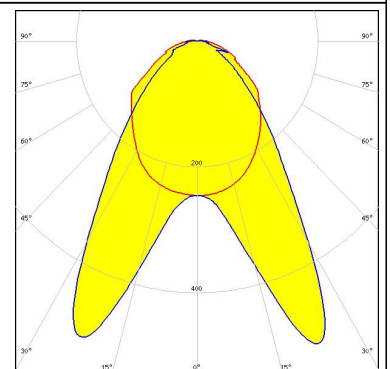

PHOTOMETRIC DATA (MEASURED):



LED NFSx757G
FWHM Asymmetric
Efficiency 85 %
Peak intensity 0.480 cd/lm
Required components:

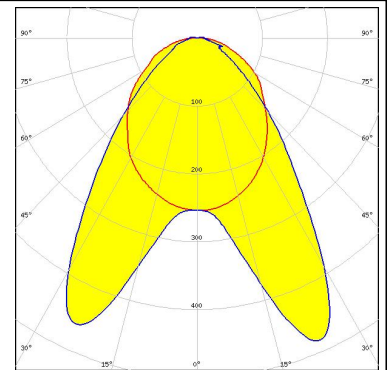

LED PrevaLED Linear Slim 3 (1100lm)
FWHM Asymmetric
Efficiency 86 %
Peak intensity 0.510 cd/lm
Required components:

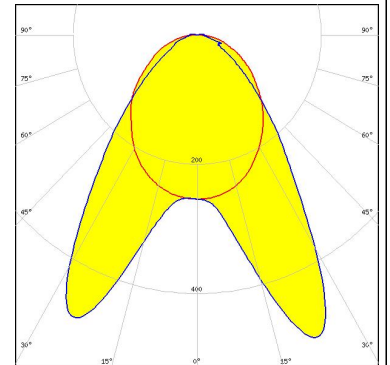

LED PrevaLED Linear Slim 3 (2000lm)
FWHM Asymmetric
Efficiency 86 %
Peak intensity 0.500 cd/lm
Required components:

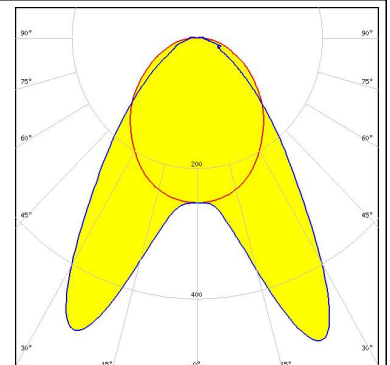

LED Duris S5 (2 chip)
FWHM Asymmetric
Efficiency 87 %
Peak intensity 0.510 cd/lm
Required components:

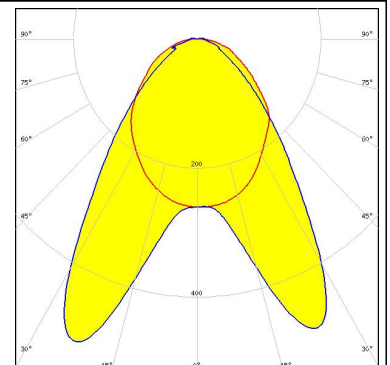

PHOTOMETRIC DATA (MEASURED):

OSRAM
Opto Semiconductors

LED Duris S5 (Single chip)
FWHM Asymmetric
Efficiency 89 %
Peak intensity 0.530 cd/lm
Required components:

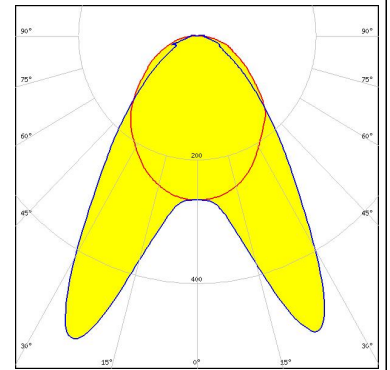

PHILIPS

LED Fortimo LED Strip 1ft 1100lm FC HV4 & LV4
FWHM Asymmetric
Efficiency 87 %
Peak intensity 0.500 cd/lm
Required components:

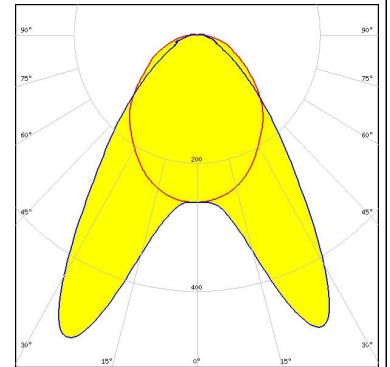

PHILIPS

LED Fortimo LED Strip 1ft 650lm FC HV4 & LV4
FWHM Asymmetric
Efficiency 87 %
Peak intensity 0.500 cd/lm
Required components:

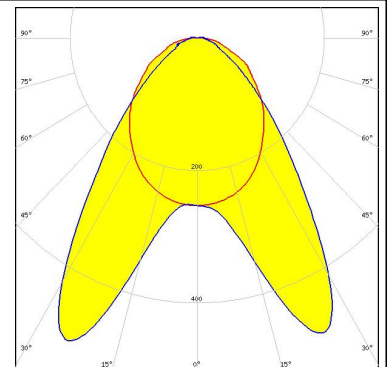

SAMSUNG

LED LM561B Plus
FWHM Asymmetric
Efficiency 87 %
Peak intensity 0.480 cd/lm
Required components:

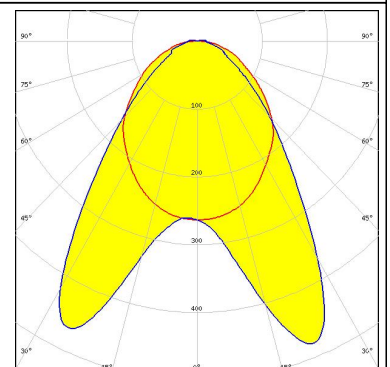

PHOTOMETRIC DATA (MEASURED):

SAMSUNG

LED LT-H282C
FWHM Asymmetric
Efficiency 87 %
Peak intensity 0.530 cd/lm
Required components:

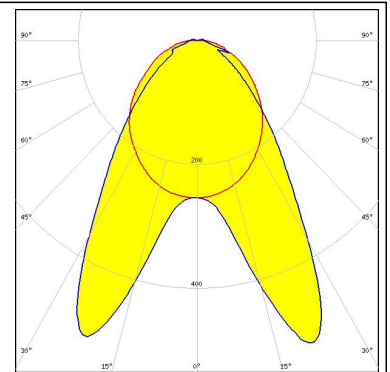

SAMSUNG

LED LT-H562C
FWHM Asymmetric
Efficiency 87 %
Peak intensity 0.530 cd/lm
Required components:

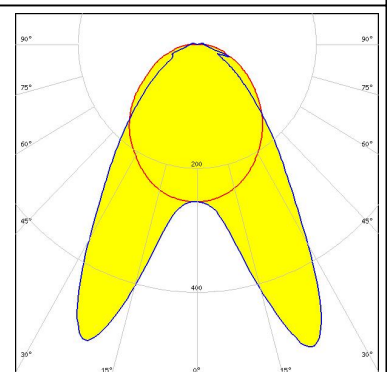

SAMSUNG

LED LT-Q282B
FWHM Asymmetric
Efficiency 87 %
Peak intensity 0.520 cd/lm
Required components:

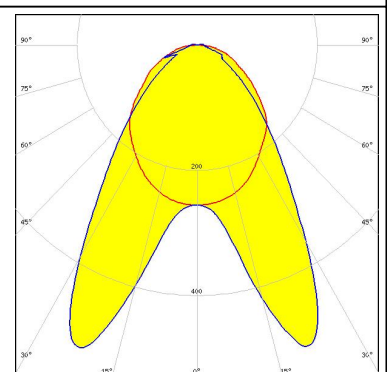

SAMSUNG

LED LT-S282H
FWHM Asymmetric
Efficiency 87 %
Peak intensity 0.540 cd/lm
Required components:

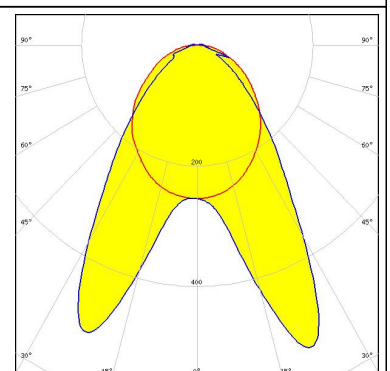

PHOTOMETRIC DATA (MEASURED):

SAMSUNG

LED LT-S562H
FWHM Asymmetric
Efficiency 87 %
Peak intensity 0.540 cd/lm
Required components:

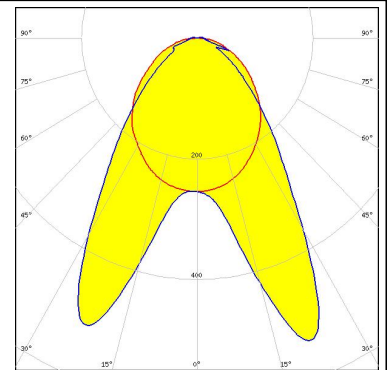

SAMSUNG

LED LT-V282E
FWHM Asymmetric
Efficiency 88 %
Peak intensity 0.540 cd/lm
Required components:

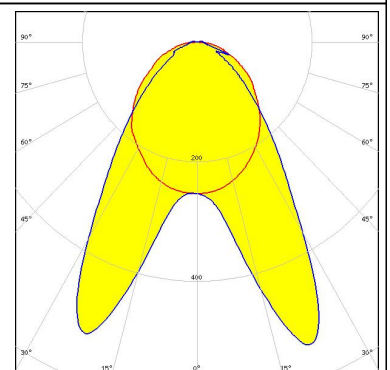

SAMSUNG

LED LT-V562E
FWHM Asymmetric
Efficiency 88 %
Peak intensity 0.540 cd/lm
Required components:

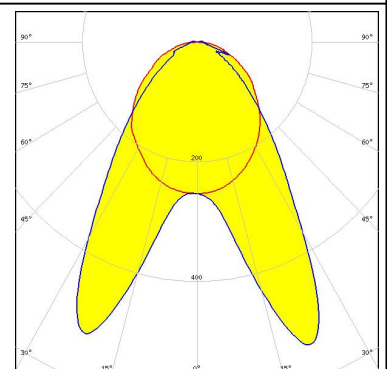

SEOUL SEMICONDUCTOR

LED SEOUL 5630D
FWHM Asymmetric
Efficiency 86 %
Peak intensity 0.490 cd/lm
Required components:

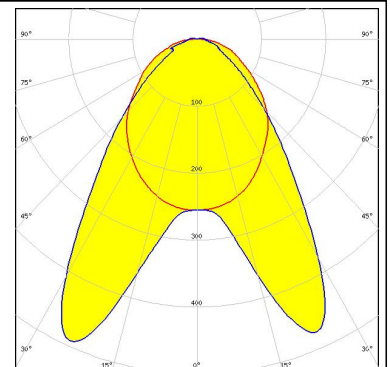
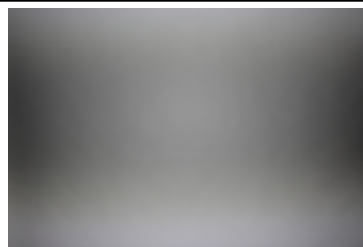

PHOTOMETRIC DATA (MEASURED):

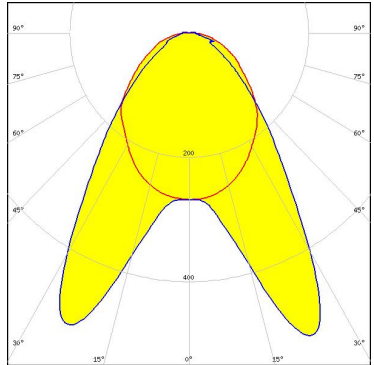
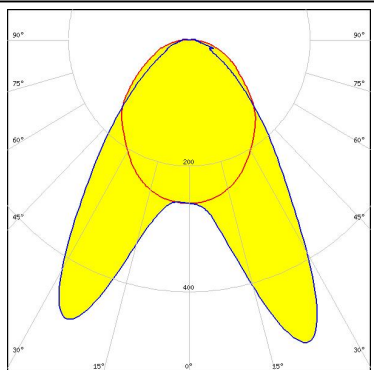
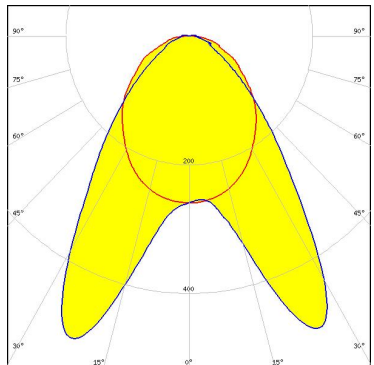
<p> SEOUL SEMICONDUCTOR</p> <p>LED SunLike 3030 FWHM Asymmetric Efficiency 88 % Peak intensity 0.530 cd/lm Required components:</p>	
<p>TRIDONIC</p> <p>LED LLE G4 24x280mm 1250lm FWHM Asymmetric Efficiency 87 % Peak intensity 0.520 cd/lm Required components:</p>	
<p>TRIDONIC</p> <p>LED LLE G4 24x280mm 650lm FWHM Asymmetric Efficiency 88 % Peak intensity 0.510 cd/lm Required components:</p>	

PHOTOMETRIC DATA (SIMULATED):

LG Innotek

LED LG 5630
FWHM Asymmetric
Efficiency 84 %
Peak intensity 0.510 cd/lm
Required components:

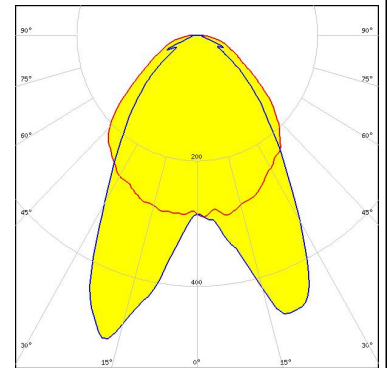

NICHIA

LED NF2x757G
FWHM Asymmetric
Efficiency 87 %
Peak intensity 0.540 cd/lm
Required components:

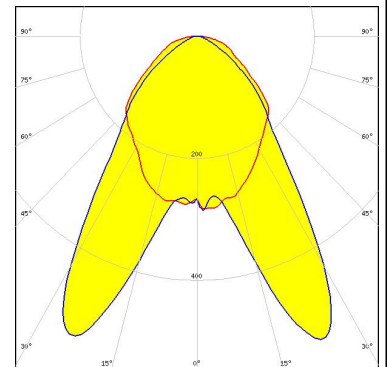

OSRAM

Opto Semiconductors
LED Duris E5
FWHM Asymmetric
Efficiency 82 %
Peak intensity 0.730 cd/lm
Required components:

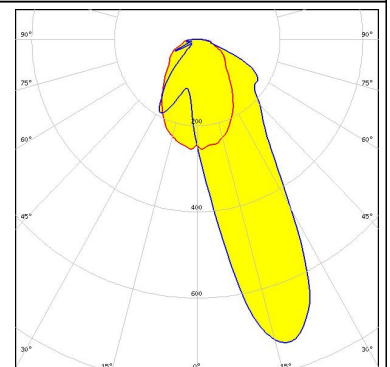

TRIDONIC

LED LLE G4 24x280mm 2000lm ADV
FWHM Asymmetric
Efficiency 88 %
Peak intensity 0.490 cd/lm
Required components:

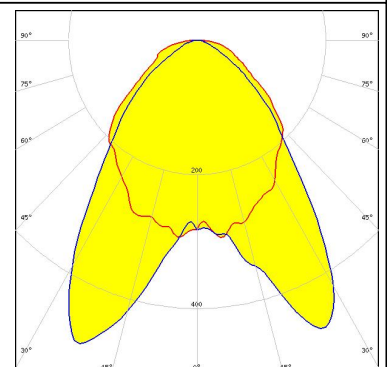

GENERAL INFORMATION:

NOTE: The typical beam angle will be changed by different color, chip size and chip position tolerance. The typical total beam angle is the full angle measured where the luminous intensity is half of the peak value.

MATERIALS:

As part of our continuous research and improvement processes, and to ensure the best possible quality and availability of our products, LEDiL reserves the right to change material grades without notice.

PRODUCT DATA USER AGREEMENT AND DISCLAIMER:

The measured data in the provided downloadable LEDiL Product Datasheets and Mechanical 2D-Drawings is rounded and provided as reference for planning. LEDiL Oy's optical specifications have been verified by conducting performance testing of the products in accordance with the company's quality system. The reported data are averaged results of multiple measurements with typical variation. LEDiL Oy reserves the right to without prior notification make changes and improvements to its products.

LEDiL Oy assumes neither warranty, nor guarantee nor any other liability of any kind for the contents and correctness of the provided data. The provided data has been generated with highest diligence but the provided data may in reality not represent the complete possible variation range of all intrinsic parameters. Therefore, in certain cases a deviation from the provided data could occur.

LEDiL Oy reserves the right to undertake technical changes of its products without further notification which could lead to changes in the provided data. LEDiL Oy assumes no liability of any kind for the possible deviation from any provided data or any other damage resulting from the usage of the provided data.

The user agrees to this disclaimer and user agreement with the download or usage of the provided files.

LEDiL Oy

Joensuunkatu 13
FI-24240 SALO
Finland

LEDiL Inc.

228 West Page Street
Suite D
Sycamore IL 60178
USA

Local sales and technical support

www.ledil.com/where_to_buy

Shipping locations

Salo, Finland
Hong Kong, China

Distribution Partners

www.ledil.com/where_to_buy