

ML610Q793 SDK BOARD Hardware Manual

ML610Q793 Demo Kit

Issue Date: Jan.22.2015.

NOTES

No copying or reproduction of this document, in part or in whole, is permitted without the consent of LAPIS Semiconductor Co., Ltd.

The content specified herein is subject to change for improvement without notice.

Examples of application circuits, circuit constants and any other information contained herein illustrate the standard usage and operations of the Products. The peripheral conditions must be taken into account when designing circuits for mass production.

Great care was taken in ensuring the accuracy of the information specified in this document. However, should you incur any damage arising from any inaccuracy or misprint of such information, LAPIS Semiconductor shall bear no responsibility for such damage.

The technical information specified herein is intended only to show the typical functions of and examples of application circuits for the Products. LAPIS Semiconductor does not grant you, explicitly or implicitly, any license to use or exercise intellectual property or other rights held by LAPIS Semiconductor and other parties. LAPIS Semiconductor shall bear no responsibility whatsoever for any dispute arising from the use of such technical information.

The Products specified in this document are intended to be used with general-use electronic equipment or devices (such as audio visual equipment, office-automation equipment, communication devices, electronic appliances and amusement devices).

The Products specified in this document are not designed to be radiation tolerant.

While LAPIS Semiconductor always makes efforts to enhance the quality and reliability of its Products, a Product may fail or malfunction for a variety of reasons.

Please be sure to implement in your equipment using the Products safety measures to guard against the possibility of physical injury, fire or any other damage caused in the event of the failure of any Product, such as derating, redundancy, fire control and fail-safe designs. LAPIS Semiconductor shall bear no responsibility whatsoever for your use of any Product outside of the prescribed scope or not in accordance with the instruction manual.

The Products are not designed or manufactured to be used with any equipment, device or system which requires an extremely high level of reliability the failure or malfunction of which may result in a direct threat to human life or create a risk of human injury (such as a medical instrument, transportation equipment, aerospace machinery, nuclear-reactor controller, fuel-controller or other safety device). LAPIS Semiconductor shall bear no responsibility in any way for use of any of the Products for the above special purposes. If a Product is intended to be used for any such special purpose, please contact a ROHM sales representative before purchasing.

If you intend to export or ship overseas any Product or technology specified herein that may be controlled under the Foreign Exchange and the Foreign Trade Law, you will be required to obtain a license or permit under the Law.

Copyright 2013-2015 LAPIS Semiconductor Co., Ltd.

LAPIS Semiconductor Co., Ltd.

2-4-8 Shinyokohama, Kouhoku-ku,
Yokohama 222-8575, Japan
<http://www.lapis-semi.com/en/>

Table of Contents

1. Read this First	1-1
1.1. Precaution for Safe and Proper Use.....	1-1
1.2. Import Safety Notes.....	1-2
1.3. Import Safety Notes.....	1-3
1.4. Inquiry	1-3
2. General Description	2-1
2.1. Overview	2-1
2.2. Main Components.....	2-2
2.3. System Connection Examples	2-4
2.4. Block Diagram.....	2-5
3. Setting	3-1
3.1. Setting operating mode of ML610Q793 SDK Board	3-1
3.1.1. Host IF switch	3-1
3.1.2. UPDATE switch	3-1
3.2. The switching of ML610Q793 SDK Board.....	3-2
3.2.1. Reset switch	3-2
4. Connectors	4-1
4.1. Connectors Pin Assignments	4-1
4.1.1. uEASE Connectors	4-1
4.1.2. SIO Connectors	4-1
4.1.3. DEBUG IF Board Connectors (DEBUG IF Board).....	4-2
4.1.4. DEBUG IF Board Connectors (SDK Board)	4-2
5. Notes	5-1
5.1. Change about the setting hardware	5-1
6. Revision History	6-1
6.1. Revision History.....	6-1

Chapter 1

Read This First



This chapter explains the first things to do when the user receives the ML610Q793 SDK Board.

Before turning on the power of the ML610Q793 SDK Board, be sure to check that you understand the contents of this chapter.

1. Read this First
1.1. Precaution for Safe and Proper Use

This manual uses various labels and icons that serve as your guides to operating this product safely and properly so as to prevent death, personal injury, and property damage. The following table lists these labels and their definitions.

Labels

 <p>Warning</p>	<p>This label indicates precautions that, if ignored or otherwise not completely followed, could lead to death or serious personal injury.</p>
 <p>Caution</p>	<p>This label indicates precautions that, if ignored or otherwise not completely followed, could lead to personal injury or property damage.</p>

Icons



A triangular icon draws your attention to the presence of a hazard. The illustration inside the triangular frame indicates the nature of the hazard—in this example, an electrical shock hazard.









A circular icon with a solid background illustrates an action to be performed. The illustration inside this circle indicates this action—in this example, unplugging the power cord.











A circular icon with a crossbar indicates prohibition. The illustration inside this circle indicates the prohibited action—in this example, disassembly.

1.2. Import Safety Notes

Please read this page before using the product.

 Warning	
Use only the specified voltage. Using the wrong voltage risks fire or electrical shock.	
At the first signs of smoke, an unusual smell, or other problems, unplug the ML610Q793 SDK BOARD and disconnect all external power cords. Continued use risks fire or electrical shock.	
Do not use the product in an environment exposing it to moisture or high humidity. Such exposure risks fire or electrical shock.	
Do not pile objects on top of the product. Such pressure risks fire or electrical shock.	
At the first signs of breakdown, immediately stop using the product, unplug the ML610Q793 SDK BOARD, and disconnect all external power cords. Continued use risks fire or electrical shock.	

 Caution	
Do not use this product on an unstable or inclined base as it can fall or overturn, producing injury.	
Do not use this product in an environment exposing it to temperatures outside the specified range, direct sunlight, or excessive dust. Such factors risk fire and breakdown.	
Do not use this product in an environment exposing it to excessive vibration, strong electromagnetic fields, or corrosive gases. Such factors can loosen or even disconnect cable connectors, producing a breakdown.	
Use only the cables and other accessories provided. Using non-compatible parts risks fire or breakdown.	
Always observe the specified order for turning equipment on and off. Using the incorrect order risks fire or breakdown.	
Do not use the cables and other accessories provided with other systems. Such improper usage risks fire.	
Always turn off the power supplies before connecting or disconnecting the cables and other accessories. Such improper handling risks fire or breakdown	

1.3. Import Safety Notes

This manual utilizes the following notational conventions for convenience.

[Note]	A “note” indicates a section of the manual that requires special attention.
[Reference]	A “reference” provides information related to the current topic and indicates the page number of a related section of the manual.
[Execution example]	An “execution example” indicates an example related to the current topic.
(note x)	“(note x)” is a reference to a numbered note that provides supplementary information lower on the same page.
[Note x]	“Note x” provides supplementary information related to the passage marked with “(note x)”.

1.4. Inquiry

Thank you for purchasing the ML610Q793 SDK Board.

Please direct any questions or comments regarding this product to your LAPIS SEMICONDUCTOR distributor or the nearest LAPIS SEMICONDUCTOR sales office.

Chapter 2

General Description

This chapter gives a general description of the ML610Q793 SDK Board.

2. General Description

2.1. Overview

The ML610Q793 SDK Board is equipped with the sensor hub microcontroller “ML610Q793”, various sensors include Accelerometer, Barometer and so on.

The ML610Q793 is a high-performance 8-bit low power microcontroller optimized for sensor hub, that integrates LAPIS Semiconductor’s original high-performance 8-bit CPU core with a 16-bit multiplier/divider co-processor, 64 KByte flash memory, 4 KByte RAM, multiple interfaces for various sensors and host interfaces with 8 KByte logging RAM in small footprint package. The ML610Q793 is an ideal sensor hub microcontroller for smart phone to separate various sensors off from its application processor and control them effectively for reducing total system power consumption.

In using the ML610Q793 SDK Board, also refer to the following document:

- ML610Q793 User’s Manual

2.2. Main Components

ML610Q793 SDK is consisted two boards for the sensor hub microcontroller SDK Board and DEBUG IF Board.

Figure 2-1 to Figure 2-2 show the top and bottom views of the ML610Q793 SDK Board and Table 2-1 to Table 2-2 lists the main components of the board.

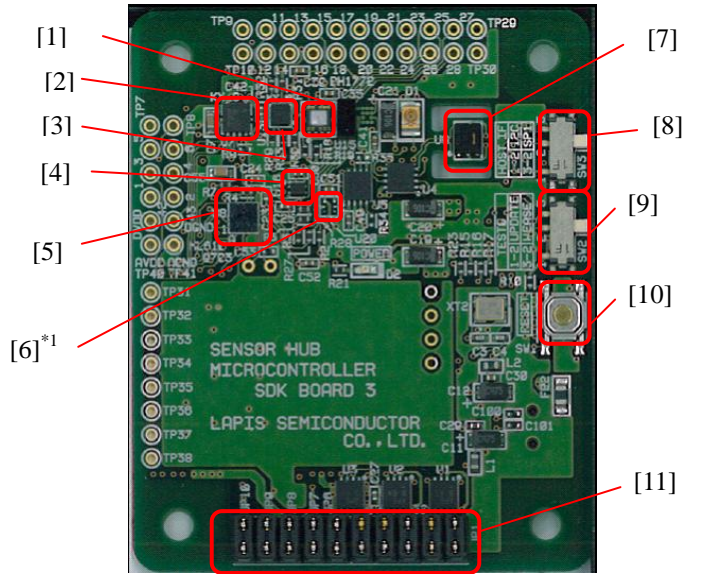

Top view

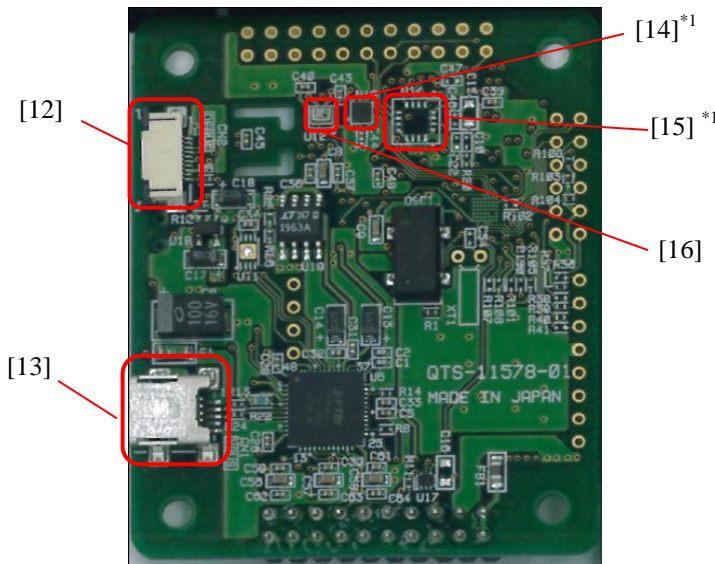

Back view

Figure 2-1 sensor hub microcontroller SDK Board

Table 2-1 Components Mounted on sensor hub microcontroller SDK Board

	Name	Description
[1]	Optical Proximity Sensor and Ambient Light Sensor	Optical Proximity Sensor and Ambient Light Sensor (BH1772GLC made by ROHM)
[2]	3-Axis Digital Accelerometer	3-Axis Digital Accelerometer (KXTF9 made by Kionix)
[3]	3-Axis Digital Accelerometer	3-Axis Digital Accelerometer (BMA250E made by BOSH)
[4]	Hall IC	Hall IC (BU52061NVX made by ROHM)
[5]	ML610Q793	Sensor hub microcontroller
[6]	UV sensor	UV sensor (ML8511HA made by LAPIS)*1
[7]	Humidity and Temperature Sensor	Humidity and Temperature Sensor (SHT20 made by SENSIRION)
[8]	HOST IF switch	Switch for selecting the mode of HOST IF
[9]	UPDATE switch	Firmware update switch
[10]	Reset switch	Reset switch for ML610Q793
[11]	HOST IF Jumper connector	Setting to use the host of SDK. IF use the other host, remove this connector from pins. In the detail, see “circuit diagram of SDK Board”.
[12]	DEBUG IF Board connector	DEBUG IF Board/10 pins FFC cable connector
[13]	USB connector	Supply Voltage for Board from USB mini B connector
[14]	Magnetic Sensor	Magnetic Sensor (AK8975B made by AsahiKASEI Elec)*1
[15]	3-Axis Gyroscope	3-Axis Gyroscope (L3G4200D made by STMicro or KGY13 made by Kionix)*1
[16]	Digital Barometer	Digital Barometer (BMP280 made by BOSH)

*1 This sensor is not implemented.

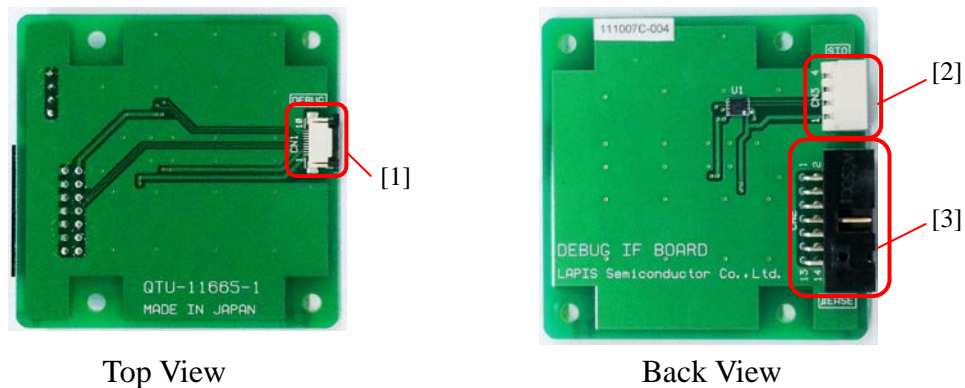

Figure 2-2 DEBUG IF Board

Table 2-2 Components Mounted on DEBUG IF Board

Number	Name	Description
1	DEBUG IF Board connector	SDK Board /10 pins FFC cable connector
2	SIO connector	UART interface connector
3	uEASE connector	uEASE connector

2.3. System Connection Examples

Figure 2-3 show examples of ML610Q793 SDK Board power supply connections.

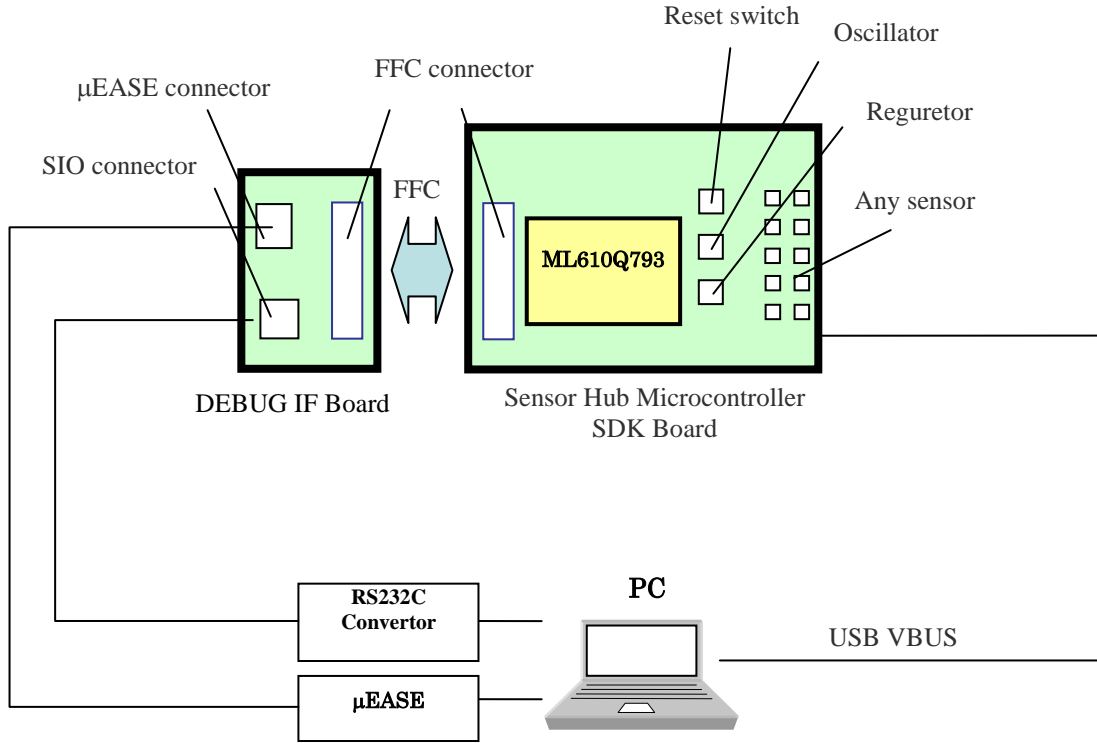
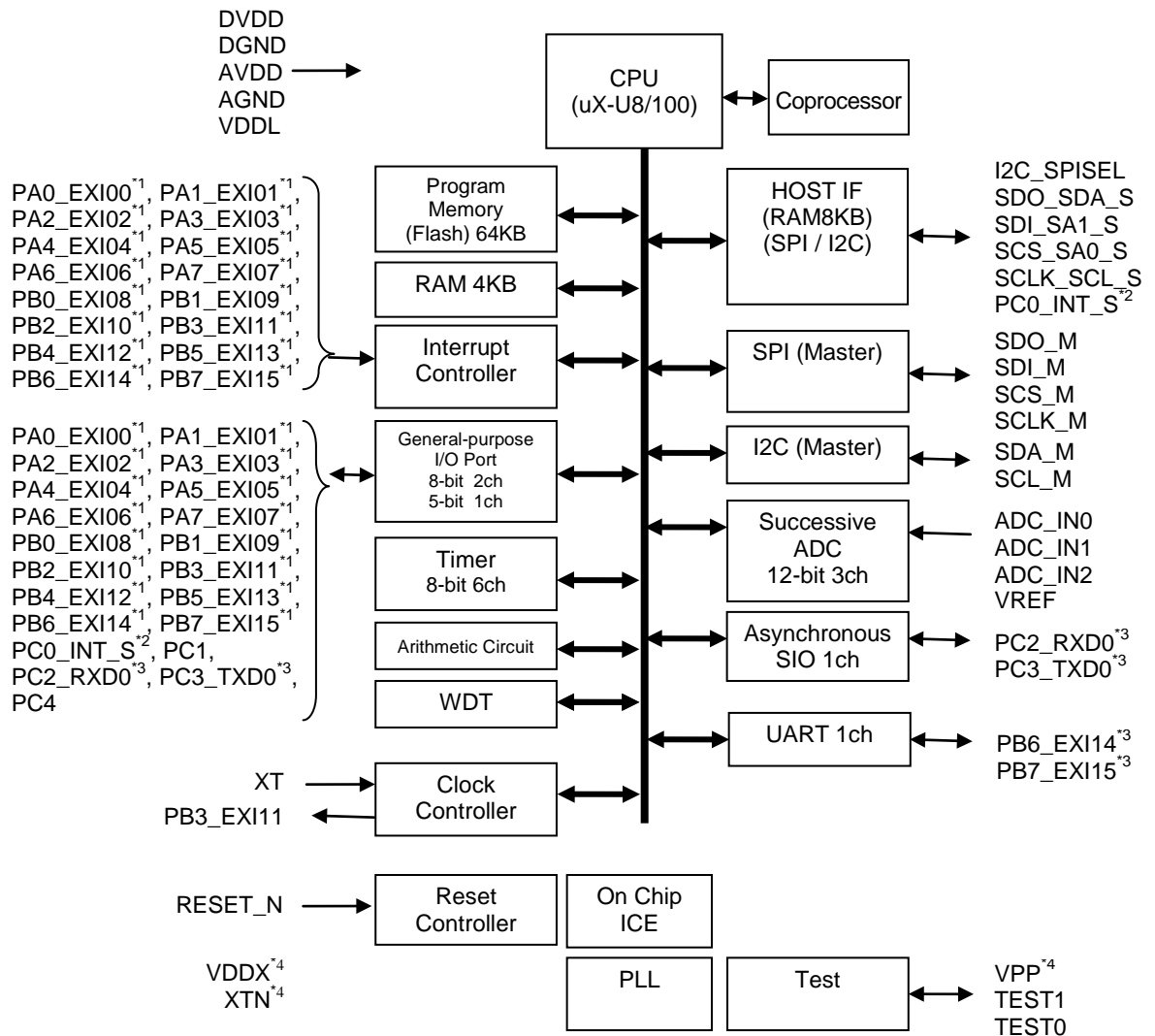

Figure 2-3 System connection example

2.4. Block Diagram

Figure 2-4 is a block diagram of the ML610Q793 and Figure 2-5 to Figure 2-7 is a block diagram SDK Board.



- *1 Shared by the interrupt pins and the general-purpose I/O port
- *2 Shared by the interrupt output pin of the host interface and the general-purpose I/O port
- *3 Shared by the UART/Asynchronous SIO transmit/receive pins and the general-purpose I/O port
- *4 Leave this pin open in ML610Q793

Figure 2-4 the block diagram of ML610Q793

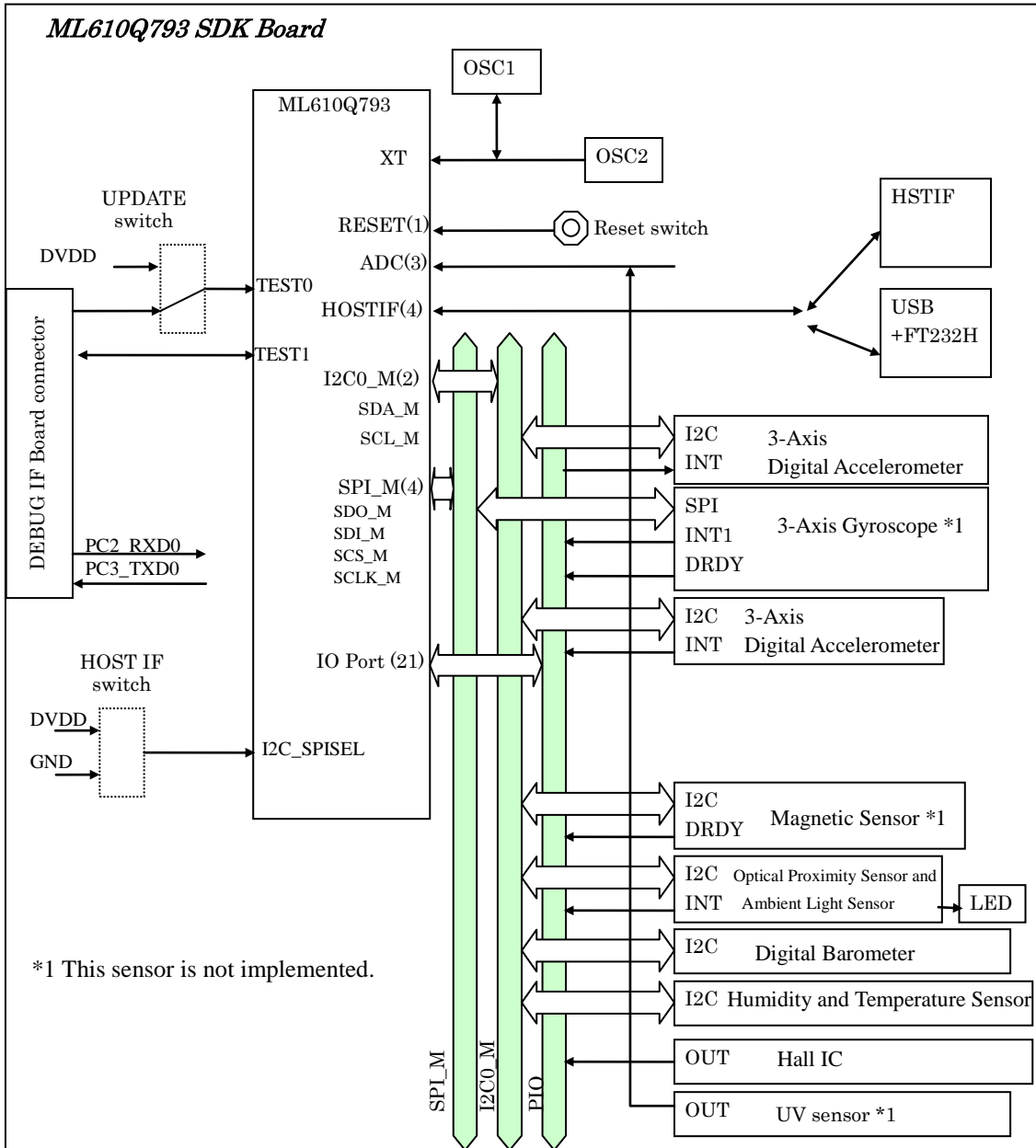

Figure 2-5 the block diagram (1) of ML610Q793 SDK Board

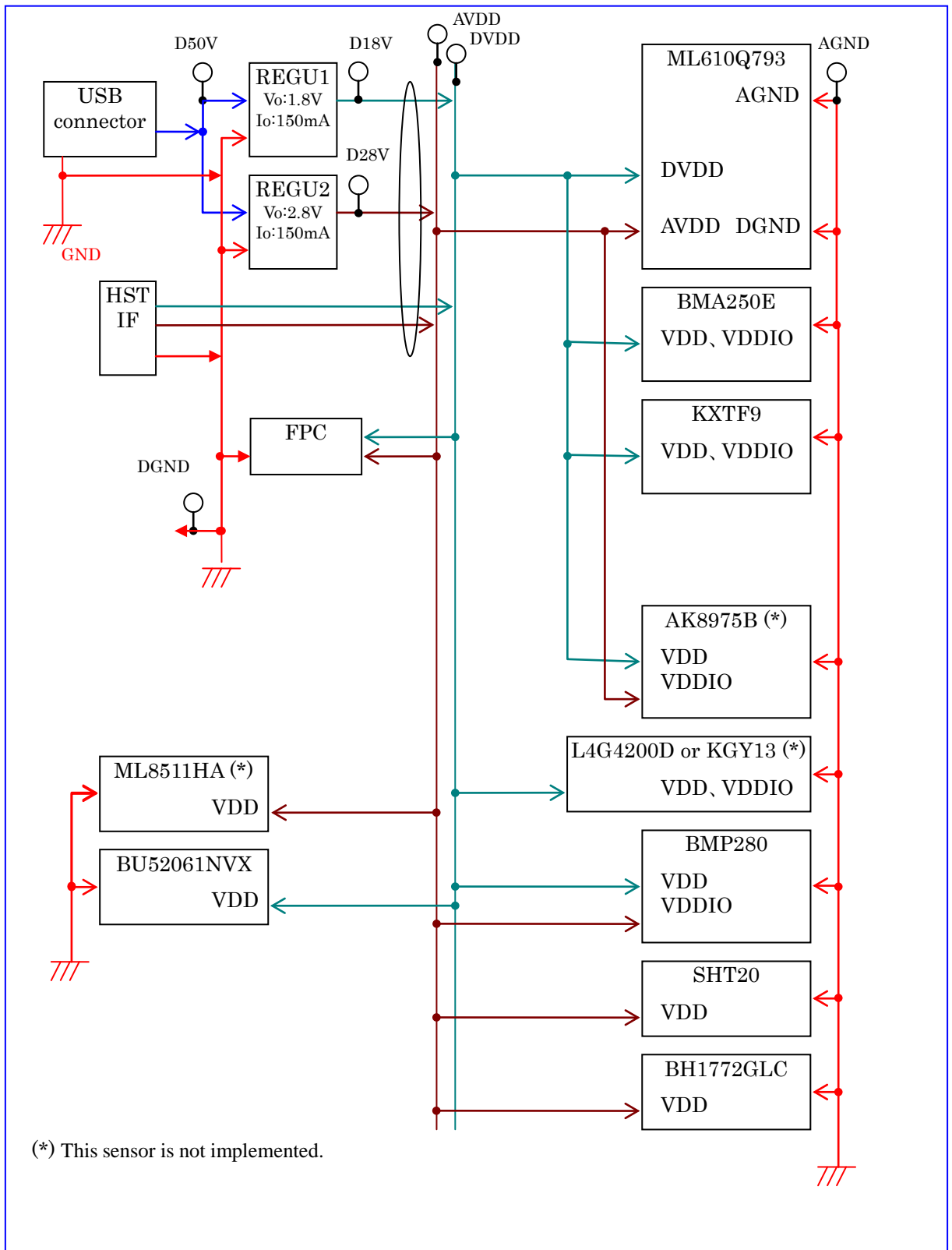

Figure 2-6 the block diagram (2) of ML610Q793 SDK Board

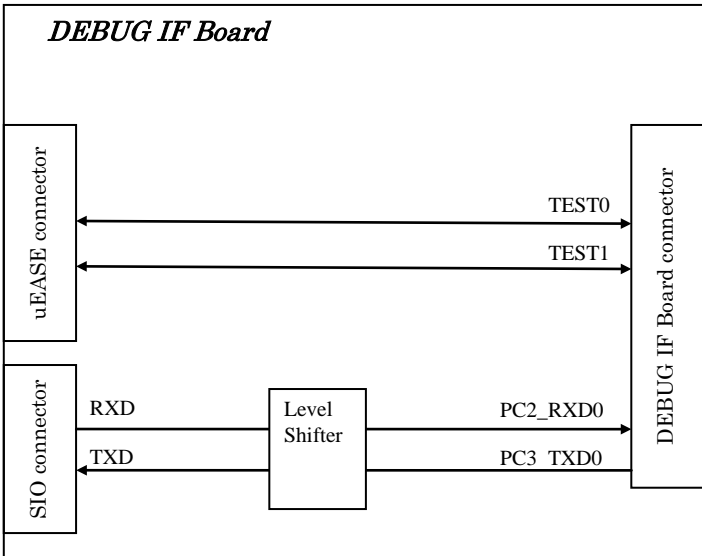

Figure 2-7 the block diagram of ML610Q793 SDK Board (DEBUG IF Board)

Chapter 3

Setting

This chapter gives a Setting operating mode of the ML610Q793 SDK Board.

3. Setting

3.1. Setting operating mode of ML610Q793 SDK Board

3.1.1. Host IF switch

ML610Q793 SDK Board enables switching the interface of host processor and microcontroller by the Host IF switch is integrated on SDK Board.

Figure 3-1 shows the Host IF switch, Table 3-1 lists the switch setting.

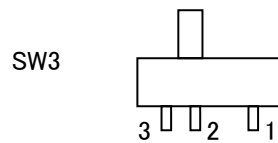

Figure 3-1 the Host IF switch

Table 3-1 the Host IF switch

Setting	Explanation
1 - 2	The interface of host processor and microcontroller is "I ² C".
2 - 3	The interface of host processor and microcontroller is "SPI". (initial value)

3.1.2. UPDATE switch

ML610Q793 SDK Board realizes the function of firmware update for microcontroller by the UPDATE switch is integrated on SDK Board.

Figure 3-2 shows the UPDATE switch, Table 3-2 lists the switch setting.

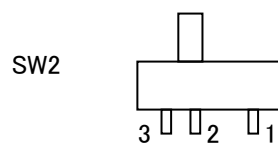

Figure 3-2 the UPDATE switch

Table 3-2 the UPDATE switch

Setting	Explanation
1 - 2	"DVDD" is applied to the TEST0 pin for firmware update.
2 - 3	The TEST0 pin connects to uEASE connector for operating normal mode and connecting to the debugger. (initial value)

3.2. The switching of ML610Q793 SDK Board

3.2.1. Reset switch

This is the RESETN pin of ML610Q793. Pressing this switch configures the CPU core and the peripheral IO circuitry as a “Reset” is assertion.

[Note]

Cutting off the connecting to the debugger when “Reset” is assertion during connects to debugger.
Assert “Reset” from the debugger during debug.



Figure 3-3 the Reset switch

Chapter 4

Connectors

This chapter describes the connectors mounted on the ML610Q793 SDK Board.

4. Connectors

4.1. Connectors Pin Assignments

4.1.1. uEASE Connectors

Table 4-1 uEASE connector Pins

Pin No.	Signal name	I/O	Destination
1	VTref	O	DVDD
2	GND	-	GND
3	Vpp	I	-
4	GND	-	-
5	RESET_N	I	test1
6	GND	-	-
7	TEST0	I/O	test0
8	GND	-	GND
9	VDDL	I	-
10	GND	-	GND
11	N.C.	-	-
12	GND	-	GND
13	UVDD_O	I	-
14	TESTMODE	O	-

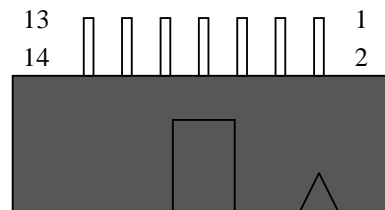

4.1.2. SIO Connectors

Table 4-2 SIO connector Pins

Pin No.	Signal name	I/O	Destination
1	5V	-	D50V
2	TXD	O	PC3_TXD0
3	RXD	I	PC2_RXD0
4	GND	-	GND

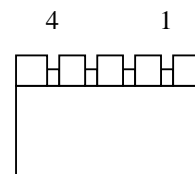

4.1.3. DEBUG IF Board Connectors (DEBUG IF Board)

Table 4-3 DEBUG IF Board connector Pins

Pin No.	Signal name	I/O
1	D50V	-
2	DVDD	-
3	DVDD	-
4	TEST0	I/O
5	TEST1	I/O
6	OPEN	-
7	TXD	I
8	RXD	O
9	GND	-
10	GND	-

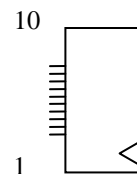

4.1.4. DEBUG IF Board Connectors (SDK Board)

Table 4-4 DEBUG IF Board connector Pins

Pin No.	Signal name	I/O
10	D50V	-
9	DVDD	-
8	DVDD	-
7	TEST0	I/O
6	TEST1	I/O
5	OPEN	-
4	PC3_TXD0	O
3	PC2_RXD0	I
2	GND	-
1	GND	-

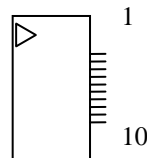

Chapter 5

Notes

This chapter describes the Notice when ML610Q793 SDK Board is used.

5. Notes

5.1. Change about the setting hardware

IF when change setting of the switch and so on, Always turn off the power supplies to avoid malfunction and breakdown.

Chapter 6

Revision History

6. Revision History

6.1. Revision History

Document No.	Date	Page		Description
		Previous Edition	Current Edition	
FEBL610Q793-01	Jun. 12, 2013	-	-	Final edition issued
FEBL610Q793-02	Jan. 22, 2015	-	-	Minor error correction